

4

3

2

1

ZONE	REV.	REVISION DESCRIPTION	ECN NO.	DATE

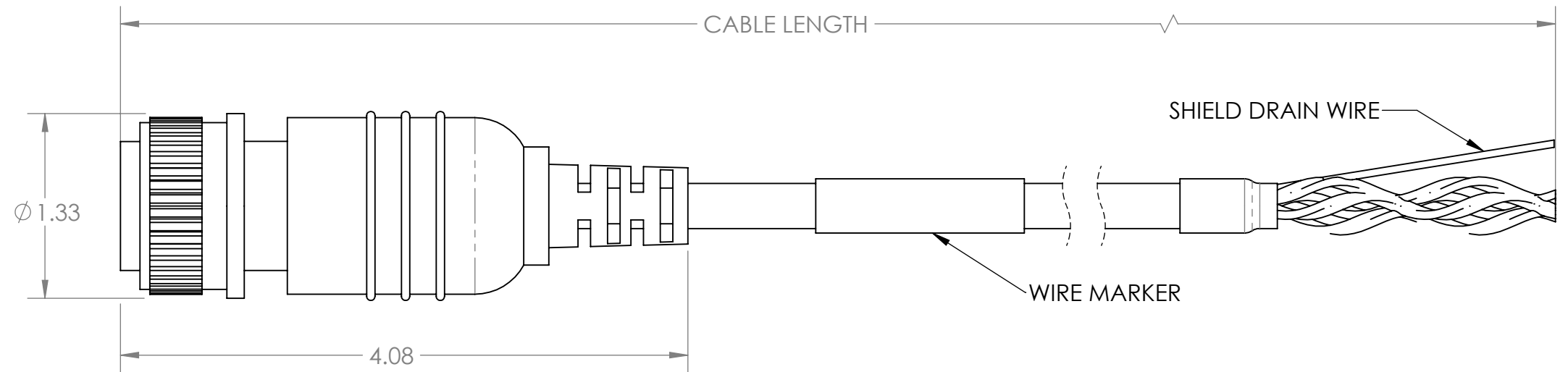
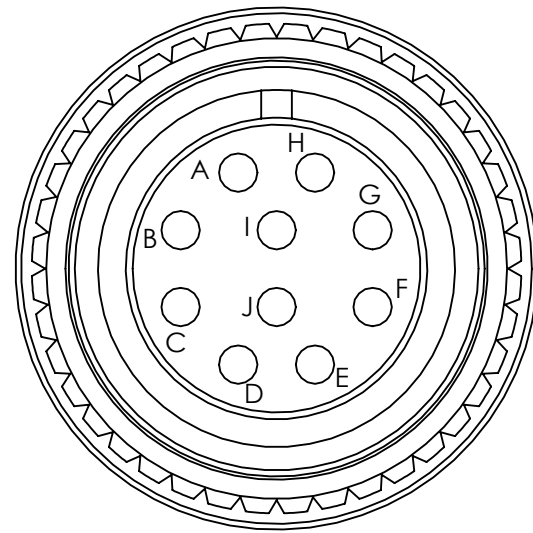

TWISTED PAIR	COLOR	PIN	WIRE GAGE
PAIR 1	YELLOW	A	AWG 24
	W/YELLO	H	
PAIR 2	BLUE	B	
	W/BLUE	I	
PAIR 3	ORANGE	C	AWG 22
	W/ORANGE	J	
PAIR 4	RED	D	
	BLACK	F	

PART NO.	CABLE LENGTH +5%/-0
31186-1810	10 FT
31186-1820	20 FT
31186-1830	30 FT
31186-1850	50 FT

APPLICATION NOTES;
 1. FOR USE WITH DIFFERENTIAL LINE DRIVER ENCODERS OR THOSE WITH COMPLIMENTARY OUTPUTS, M18 CONNECTOR
 2. CABLE SHIELD IS NOT CONNECTED AT CONNECTOR. SHIELD CONNECTION MAY BE REQUIRED AT CONTROLLER END FOR SAFETY AND NOISE IMMUNITY.

NOTES (UNLESS OTHERWISE INDICATED)

- MAT'L: MS310618-1S INLINE PLUG, 37048-003 CABLE, BLACK POLYURETHANE OVERMOLD
- OPERATING TEMP -40 TO +80°C
- STANDARD BEI (SENSATA) PINOUT/WIRE COLOR

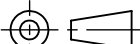
UNCONTROLLED COPY		 BEI SENSORS 1461 LAWRENCE DRIVE THOUSAND OAKS, CA 93120	
FIRST ISSUE DATE: 04/04/19 DRAWN: DRC APPROVED: MFB DATE: 04/04/19	SENSATA TECHNOLOGIES PROPRIETARY AND CONFIDENTIAL. NEITHER THIS PRINT NOR THE INFORMATION CONTAINED HEREON IS TO BE USED AGAINST THE INTERESTS OF SENSATA TECHNOLOGIES OR AGAINST THE INTERESTS OF ANY OF ITS AFFILIATED COMPANIES OR WHOLLY OWNED SUBSIDIARIES.		TITLE <h2 style="text-align: center;">M18 CONNECTOR AND CABLE ASSY</h2>
ECN: DATE: MATERIAL:	INTERPRET DIMENSIONING AND TOLERANCING PER ASME Y14.5-2009. UNLESS OTHERWISE SPECIFIED DIMENSIONS ARE IN INCHES [MILLIMETERS] AND ARE INTENDED AS NOMINAL SEE PRODUCT SPECIFICATIONS FOR MORE DETAILS.		SIZE B
DO NOT SCALE DRAWING THIRD ANGLE PROJECTION			DWG NO. <h1 style="text-align: center;">09911-001</h1>
SCALE 1:1		SOLIDWORKS	SHEET 1 OF 1

4

3

2

1

DEVICE: PROJECT: